











36 200 661



- rotary diverter
- without rosette
- handle Ø 60mm
- with shut-off function

|  |                               |                    |
|--|-------------------------------|--------------------|
|   | Chrome                        | 36 200 661-00 0010 |
|   | Brushed Platinum              | 36 200 661-06 0010 |
|   | Light Gold                    | 36 200 661-26 0010 |
|   | Brushed Light Gold            | 36 200 661-27 0010 |
|   | Matte Black                   | 36 200 661-33 0010 |
|   | Brushed Bronze                | 36 200 661-42 0010 |
|   | Brushed Champagne (22kt Gold) | 36 200 661-46 0010 |
|   | Champagne (22kt Gold)         | 36 200 661-47 0010 |
|   | Brushed Chrome                | 36 200 661-93 0010 |
|  | Brushed Dark Platinum         | 36 200 661-99 0010 |

**Required miscellaneous**



- Concealed two-way diverter -** 35 202 970-90
- max. recess depth 160 mm 0010
  - min. recess depth 115 mm

36 200 661

mm [inches]

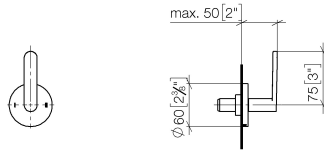

**Flow rate chart**



**Codes & Standards**

California Energy  
Commission  
(CEC)



## META Concealed two-way diverter - Chrome

---

META

36 200 661

### Certificates

---

IAPMO\_4976 (7).

36 200 661

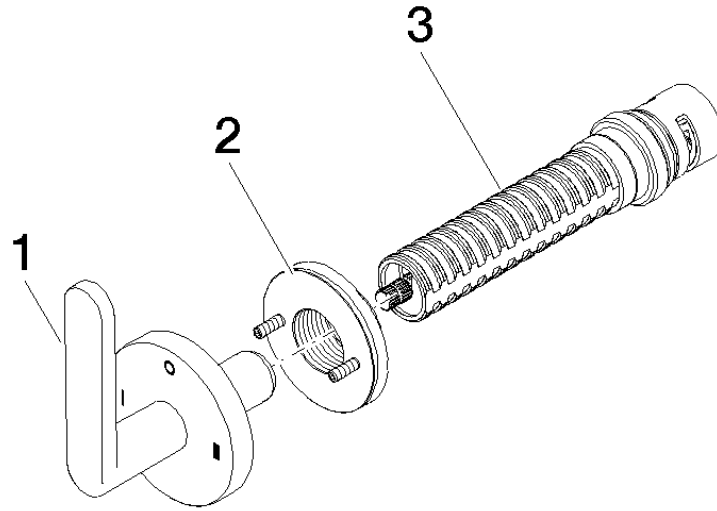

**Spare parts list**

| No. | Item Number        | Name     | Quantity used | Delivery time |
|-----|--------------------|----------|---------------|---------------|
| 1   | 90 20 66 014 01-00 | handle   | 1             | 10            |
| 2   | 90 21 02 181 00 90 | disc     | 1             | 2             |
| 3   | 90 90 03 306 10 90 | diverter | 1             | 2             |